

Features

- Output voltage tolerance $\leq \pm 2\%$
- Low-drop voltage
- Very low current consumption
- Overtemperature protection
- Short-circuit proof
- Suitable for use in automotive electronics
- Reverse polarity

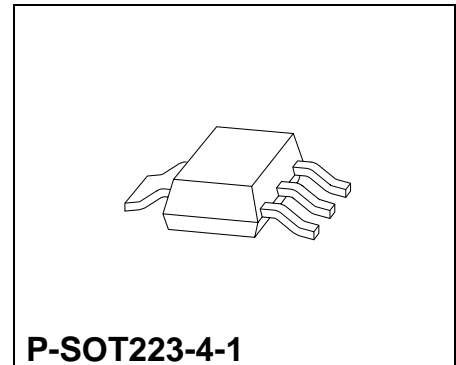

Type	Ordering Code	Package
TLE 4264 G	Q67006-A9139	P-SOT223-4-1 (SMD)

Functional Description

TLE 4264 G is a 5-V low-drop fixed-voltage regulator in an SOT-223 package. The IC regulates an input voltage V_I in the range $5.5\text{ V} < V_I < 45\text{ V}$ to $V_{Q_{\text{rated}}} = 5.0\text{ V}$. The maximum output current is more than 120 mA. This IC is shortcircuit-proof and features temperature protection that disables the circuit at overtemperature.

Dimensioning Information on External Components

The input capacitor C_i is necessary for compensating line influences. Using a resistor of approx. $1\ \Omega$ in series with C_i , the oscillating of input inductivity and input capacitance can be clamped. The output capacitor C_Q is necessary for the stability of the regulating circuit. Stability is guaranteed at values $C_Q \geq 10\ \mu\text{F}$ and an $\text{ESR} \leq 10\ \Omega$ within the operating temperature range.

Pin Configuration

(top view)

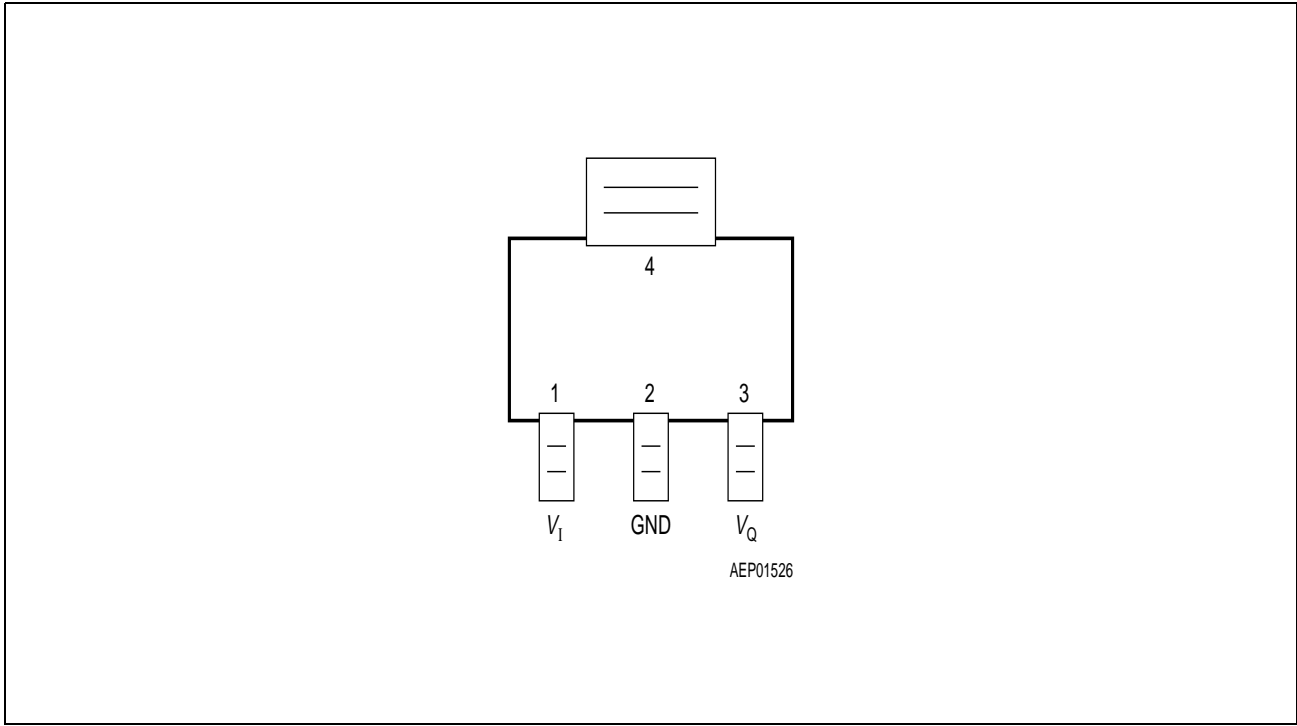

Pin Definitions and Functions

Pin	Symbol	Function
1	V_I	Input voltage; block to ground directly on IC with ceramic capacitor
2, 4	GND	Ground
3	V_Q	5-V output voltage; block to ground with $\geq 10\text{-}\mu\text{F}$ capacitor, ESR < 10 Ω

Circuit Description

The control amplifier compares a reference voltage, which is kept highly precise by resistance adjustment, to a voltage that is proportional to the output voltage and drives the base of the series transistor via a buffer. Saturation control, working as a function of load current, prevents any over-saturation of the power element. The IC is additionally protected against overload, overtemperature and reverse polarity.

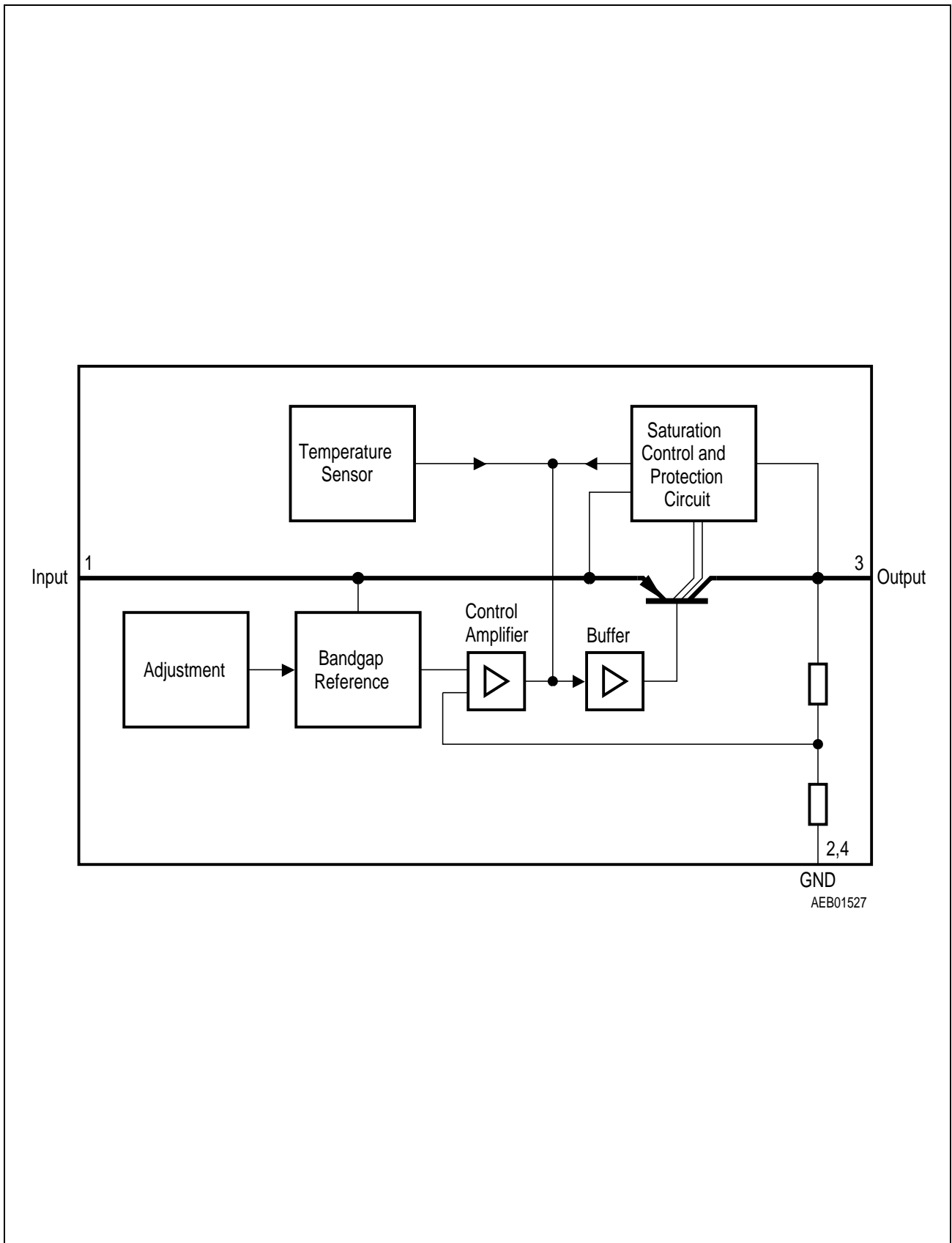

Block Diagram

Absolute Maximum Ratings

$T_j = -40$ to 150 °C

Parameter	Symbol	Limit Values		Unit	Notes
		min.	max.		

Input

Input voltage	V_I	- 42	45	V	-
Input current	I_I	-	-	-	limited internally

Output

Output voltage	V_Q	- 1	16	V	-
Output current	I_Q	-	-	-	limited internally

Ground

Current	I_{GND}	50	-	mA	-
---------	-----------	----	---	----	---

Temperatures

Junction temperature	T_j	-	150	°C	-
Storage temperature	T_{stg}	- 50	150	°C	-

Operating Range

Input voltage	V_I	5.5	45	V	-
Junction temperature	T_j	- 40	150	°C	-

Thermal Resistances

System-air	$R_{th SA}$	-	100	K/W	soldered in
System-case	$R_{th SC}$	-	25	K/W	-

Characteristics

$V_1 = 13.5 \text{ V}$; $-40 \text{ °C} \leq T_j \leq 125 \text{ °C}$, unless specified otherwise

Parameter	Symbol	Limit Values			Unit	Test Conditions
		min.	typ.	max.		
Output voltage	V_Q	4.9	5.0	5.1	V	$5 \text{ mA} \leq I_Q \leq 100 \text{ mA}$ $6 \text{ V} \leq V_1 \leq 28 \text{ V}$
Output-current limiting	I_Q	120	150	–	mA	–
Current consumption $I_q = I_1 - I_Q$	I_q	–	–	400	μA	$I_Q = 1 \text{ mA}$
Current consumption $I_q = I_1 - I_Q$	I_q	–	10	15	mA	$I_Q = 100 \text{ mA}$
Drop voltage	V_{dr}	–	0.25	0.5	V	$I_Q = 100 \text{ mA}^{1)}$
Load regulation	ΔV_Q	–	–	40	mV	$I_Q = 5 \text{ to } 100 \text{ mA}$ $V_1 = 6 \text{ V}$
Supply-voltage regulation	ΔV_Q	–	15	30	mV	$V_1 = 6 \text{ to } 28 \text{ V}$ $I_Q = 5 \text{ mA}$
Supply voltage suppression	SVR	–	54	–	dB	$f_r = 100 \text{ Hz}$ $V_r = 0.5 \text{ Vpp}$

¹⁾ Drop voltage = $V_1 - V_Q$ (measured where V_Q has dropped 100 mV from the nominal value obtained at $V_1 = 13.5 \text{ V}$)

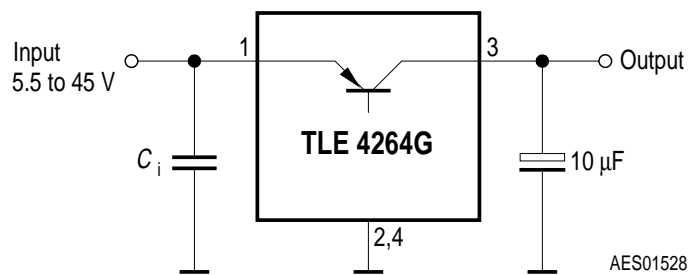

Application Circuit

Drop Voltage V_{Dr} versus Output Current I_Q

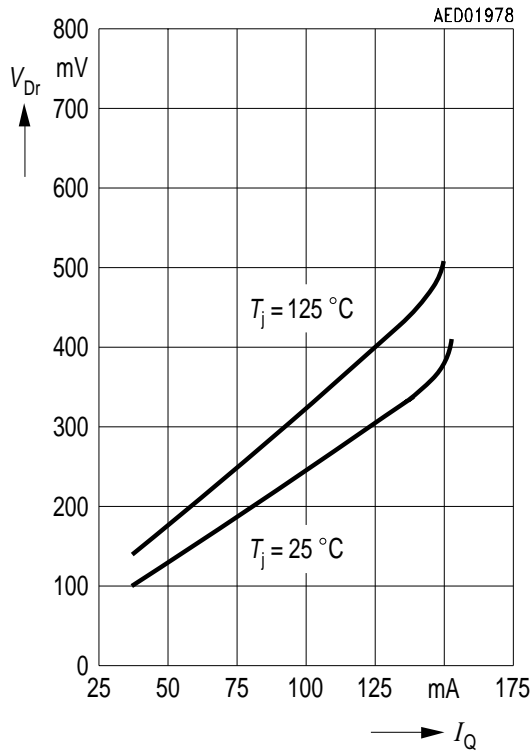

Current Consumption I_q versus Input Voltage V_i

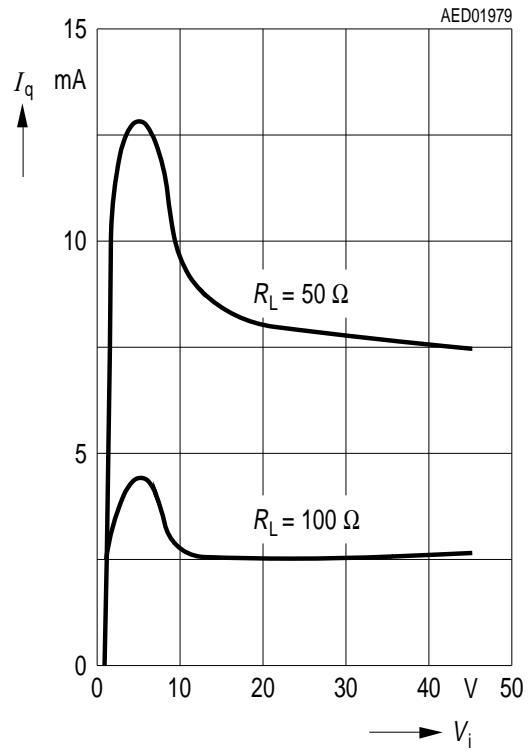

Current Consumption I_q versus Output Current I_Q

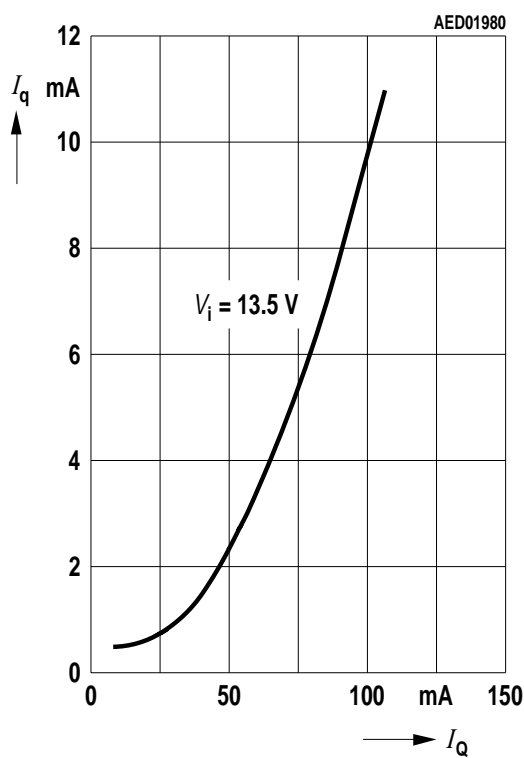

Current Consumption I_q versus Output Current I_Q

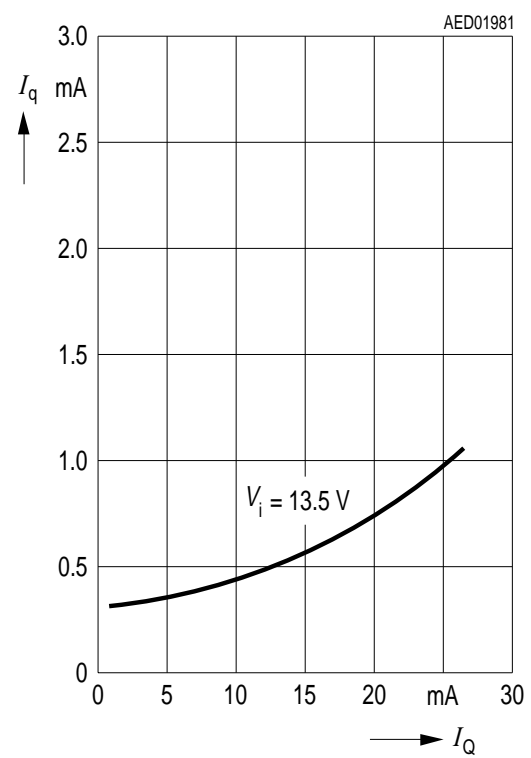

Output Voltage V_Q versus Temperature T_j

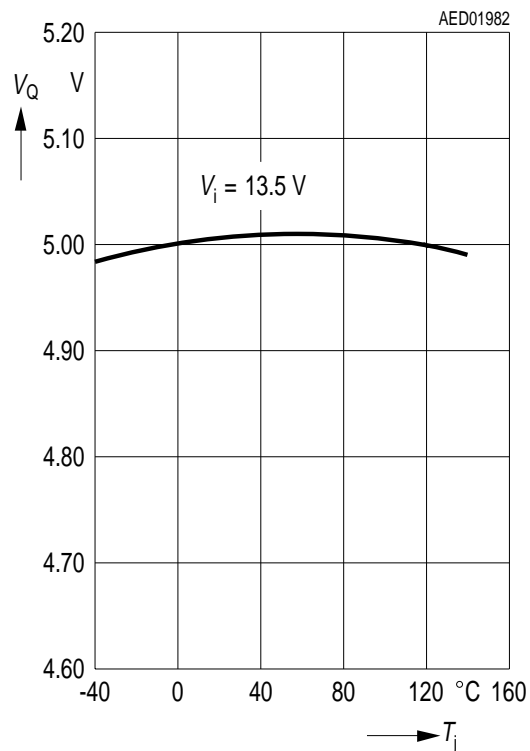

Output Current I_Q versus Input Voltage V_i

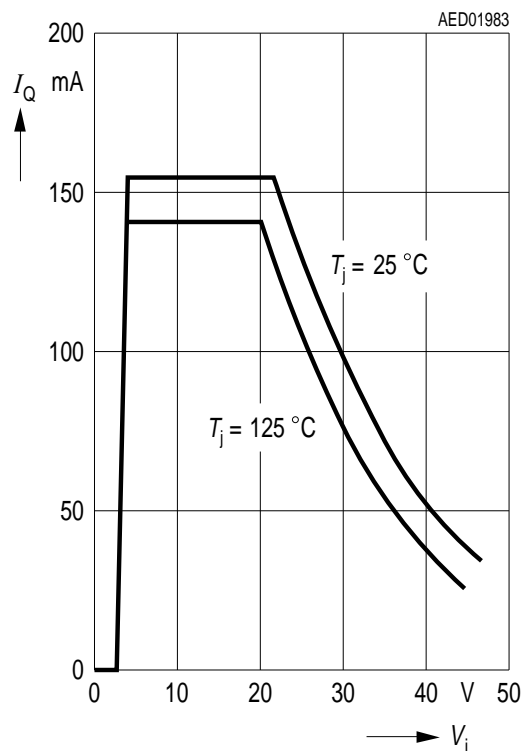

Output Voltage V_Q versus Input Voltage V_i

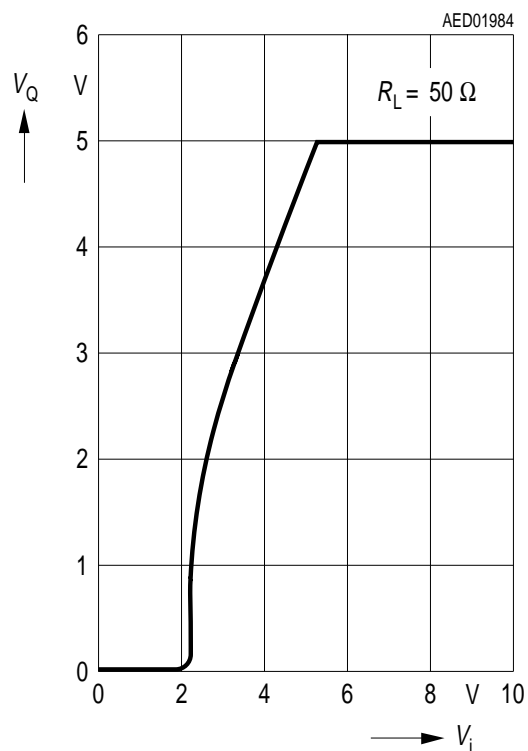

Package Outlines

P-SOT223-4-1 (Plastic Small Outline Transistor)

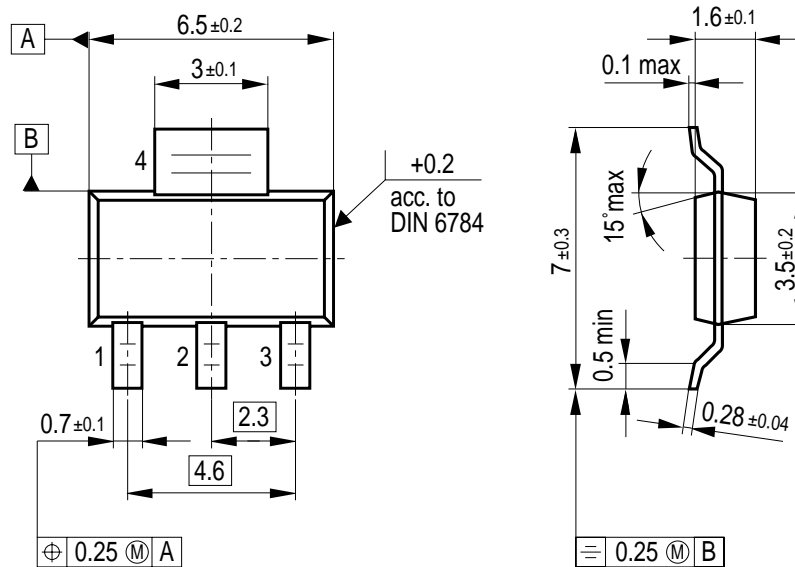

Weight approx. 0.15 g

GPS05560

Sorts of Packing

Package outlines for tubes, trays etc. are contained in our Data Book "Package Information"

SMD = Surface Mounted Device

Dimensions in mm

This datasheet has been downloaded from:

www.DatasheetCatalog.com

Datasheets for electronic components.