

THOMSON-EFCIS

Integrated Circuits

TBA820

AF AMPLIFIER

The TBA820 is a monolithic integrated audio power amplifier.
Its main features:

- working with supply voltages from 3 to 16 volts,
 - low idle current (4 mA typ.),
 - high efficiency,
- make it especially suitable for mobile, battery operated equipments.

Other features include:

- output power up to 2W without any external heat sink,
- high input impedance, low bias current,
- high ripple rejection,
- no thermal runaway,
- no cross-over distortion,
- few external components required.

The TBA820 is supplied in a quad-in-line, 14 leads package.

AF AMPLIFIER

CASE CB-21

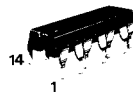

PLASTIC-PACKAGE

PIN CONFIGURATION

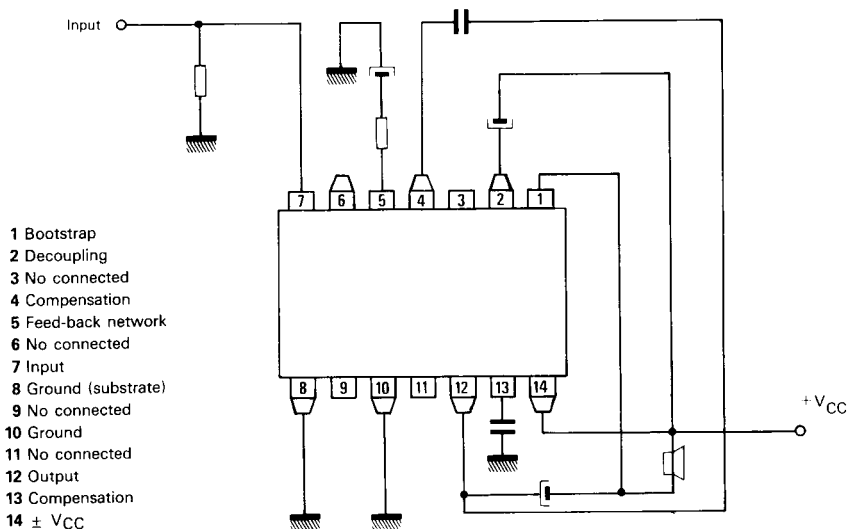

NT7905-A 1/8

THOMSON-EFCIS

Sales headquarters
45, av. de l'Europe - 78140 VELIZY - FRANCE
Tel.: (3) 946 97 19 / Telex : 204780 F

 **THOMSON-CSF**
COMPONENTS

ABSOLUTE RATINGS (LIMITING VALUES)

Rating	Symbol	Value	Unit
Supply voltage	V _{CC}	16	V
Output peak current	I _O	1.5	A
Storage temperature	T _{stg}	- 40, + 150	°C
Junction temperature	T _j	+ 150	°C

Min T_j = -40 from T_{stg}

THERMAL CHARACTERISTICS

Characteristic	Symbol	Value	Unit
Junction-ambient thermal resistance	R _{th(j-a)}	80	°C/W

SCHEMATIC DIAGRAM

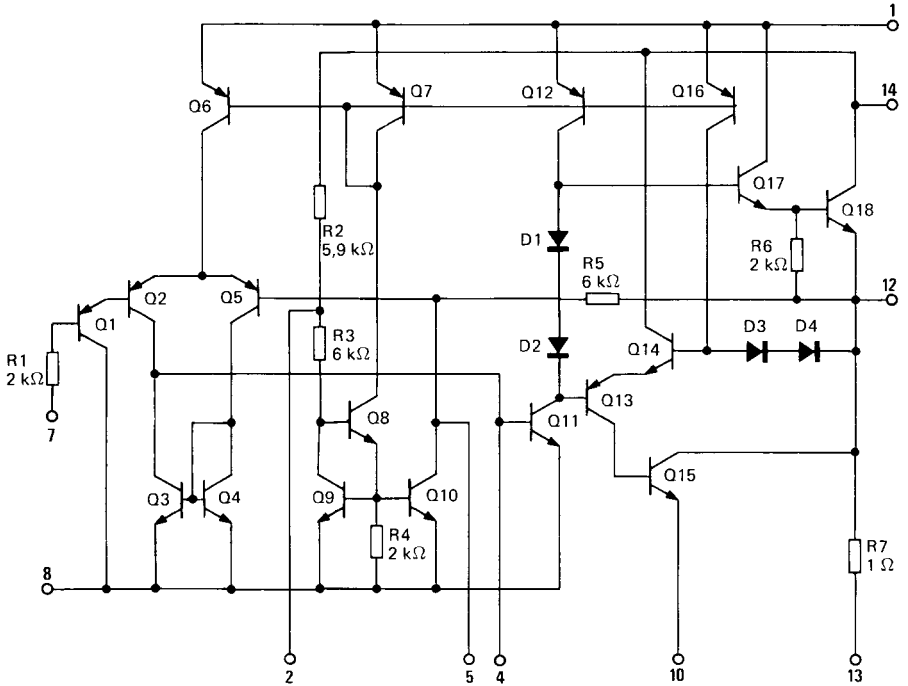

ELECTRICAL CHARACTERISTICS

T_{amb} = 25°C (note 1)

(Unless otherwise stated)

Characteristic	Symbol	Min.	Typ.	Max.	Unit
Supply voltage	V _{CC}	3	—	16	V
Quiescent output voltage V _{CC} = 9 V	Pin 12 V _O	4	4.5	5	V
Quiescent drain current V _{CC} = 9 V	I _{CC}	—	4	—	mA
Bias current V _{CC} = 9 V	Pin 7 I	—	0.1	—	μA
Output power V _{CC} = 12 V ; R _L = 8 Ω ; R _f = 120 Ω ; d = 10 % ; f = 1 kHz V _{CC} = 9 V ; R _L = 4 Ω ; R _f = 120 Ω ; d = 10 % ; f = 1 kHz V _{CC} = 9 V ; R _L = 8 Ω ; R _f = 120 Ω ; d = 10 % ; f = 1 kHz V _{CC} = 6 V ; R _L = 4 Ω ; R _f = 120 Ω ; d = 10 % ; f = 1 kHz V _{CC} = 3.5 V ; R _L = 4 Ω ; R _f = 120 Ω ; d = 10 % ; f = 1 kHz	P _O	—	2 1.6 1.2 0.75 0.22	—	W
Input sensitivity V _{CC} = 9 V ; P _O = 1.2 W ; R _L = 8 Ω ; R _f = 33 Ω ; f = 1 kHz V _{CC} = 9 V ; P _O = 1.2 W ; R _L = 8 Ω ; R _f = 120 Ω ; f = 1 kHz V _{CC} = 9 V ; P _O = 50 mW ; R _L = 8 Ω ; R _f = 33 Ω ; f = 1 kHz V _{CC} = 9 V ; P _O = 50 mW ; R _L = 8 Ω ; R _f = 120 Ω ; f = 1 kHz	S	—	16 60 3.5 12	—	mV
Input resistance	R _I	—	5	—	MΩ
Frequency response (-3 dB) V _{CC} = 9 V ; R _L = 8 Ω ; R _f = 120 Ω ; C _B = 680 pF V _{CC} = 9 V ; R _L = 8 Ω ; R _f = 120 Ω ; C _B = 220 pF	B	25 to 7.000 25 to 20.000			Hz
Distortion V _{CC} = 9 V ; P _O = 500 mW ; R _L = 8 Ω ; R _f = 33 Ω ; f = 1 kHz V _{CC} = 9 V ; P _O = 500 mW ; R _L = 8 Ω ; R _f = 120 Ω ; f = 1 kHz	d	—	0.8 0.4	—	%
Voltage gain (open loop) V _{CC} = 9 V ; R _L = 8 Ω ; f = 1 kHz	A _V	—	75	—	dB
Voltage gain (closed loop) V _{CC} = 9 V ; R _L = 8 Ω ; R _f = 33 Ω ; f = 1 kHz V _{CC} = 9 V ; R _L = 8 Ω ; R _f = 120 Ω ; f = 1 kHz	A _V	—	45 34	—	dB
Input noise voltage V _{CC} = 9 V ; B (-3 dB) = 25 to 20.000 Hz	V _n	—	3	—	μV _{eff}
Input noise current V _{CC} = 9 V ; B (-3 dB) = 25 to 20.000 Hz	I _n	—	0.4	—	
Signal to noise ratio V _{CC} = 9 V ; R _L = 8 Ω ; R _f = 120 Ω ; R ₁ = 100 kΩ P _O = 1.2 W ; B (-3 dB) = 25 to 20.000 Hz		—	70	—	dB
Supply voltage rejection (see fig. 2) V _{CC} = 9 V ; R _L = 8 Ω ; R _f = 120 Ω ; C ₆ = 50 μF f (ripple) = 100 Hz	SVR	—	42	—	dB

Note 1: The characteristics above were obtained using the circuit shown in fig. 1.

TEST AND APPLICATION CIRCUITS

FIGURE 1 — LOAD CONNECTED TO THE SUPPLY VOLTAGE

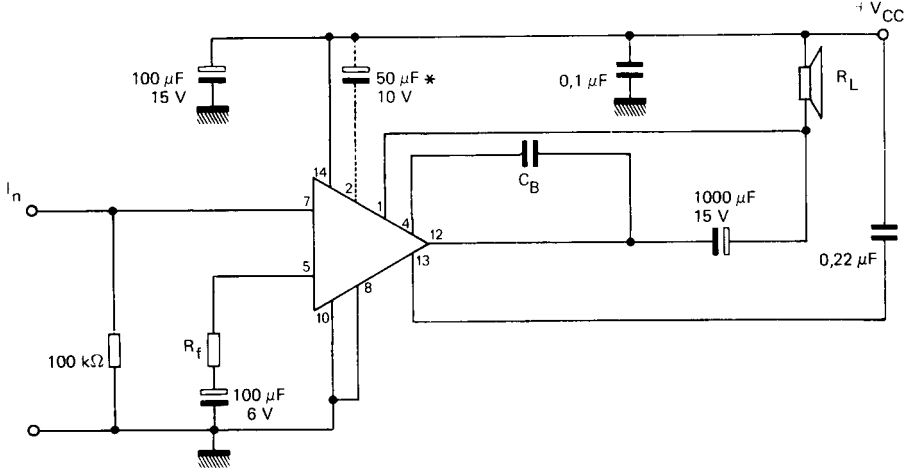
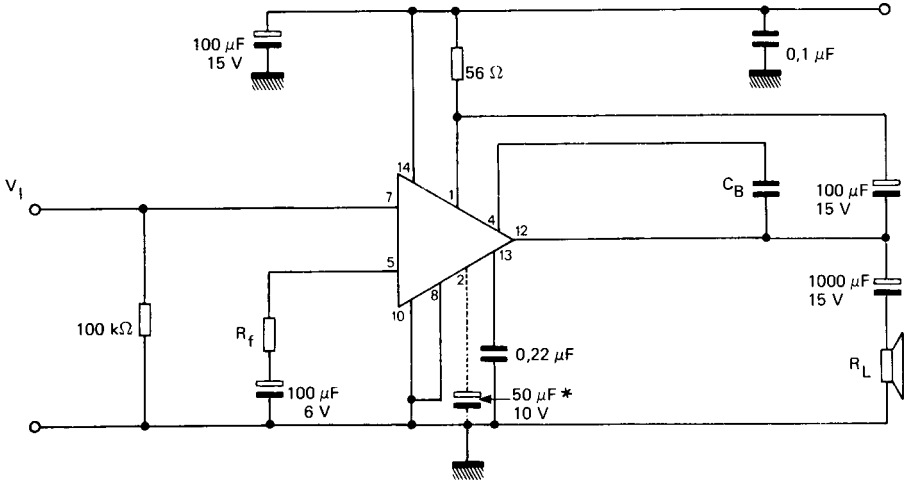
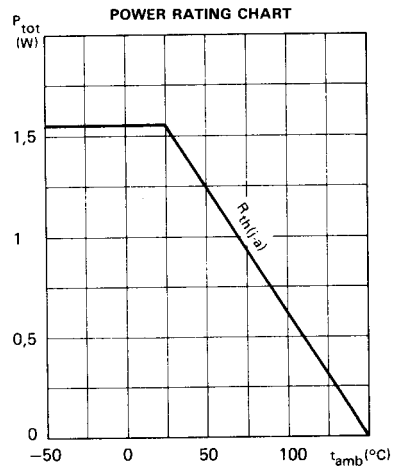
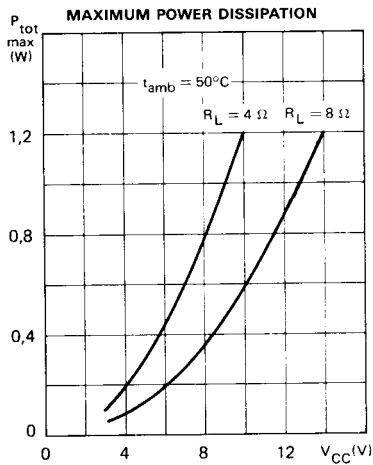
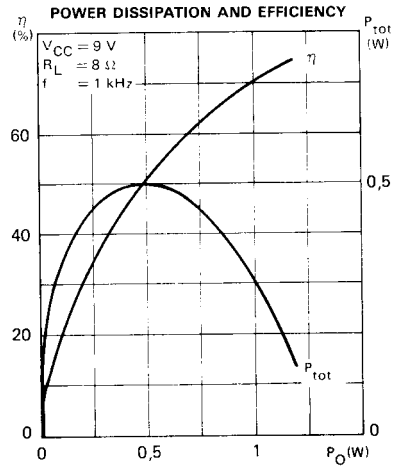
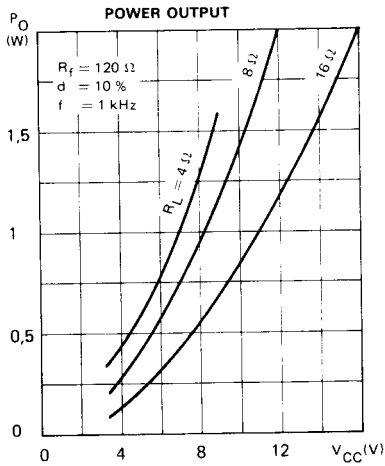

FIGURE 2 — LOAD CONNECTED TO GROUND



*Must be used when high ripple rejection is requested.

TYPICAL CHARACTERISTICS



TYPICAL CHARACTERISTICS

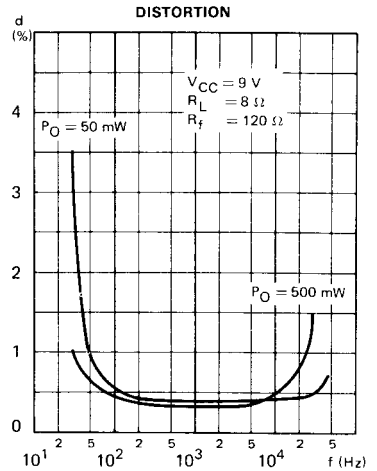
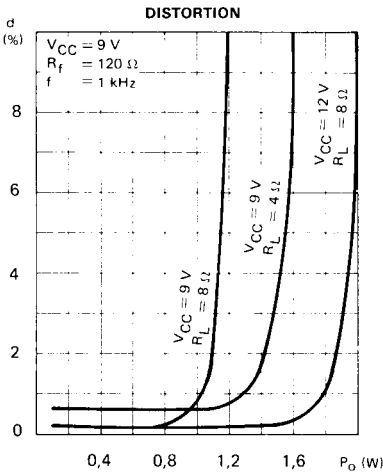
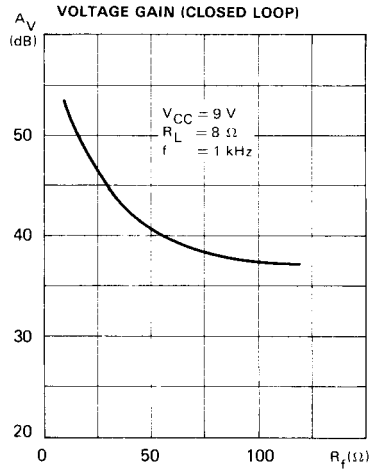
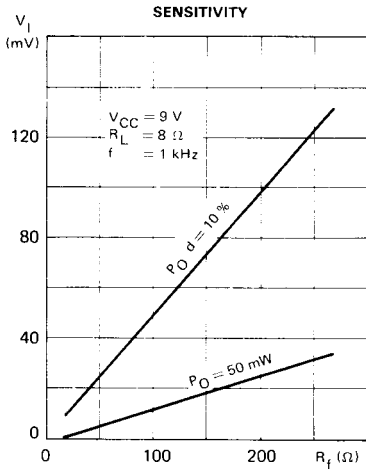

TYPICAL CHARACTERISTICS

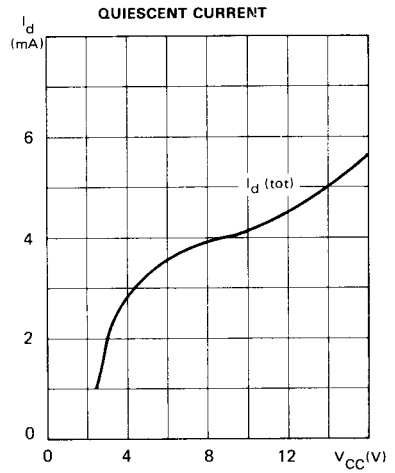
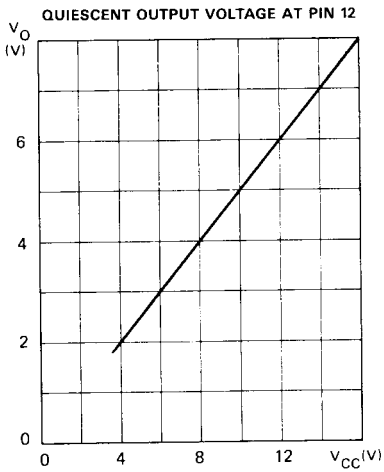
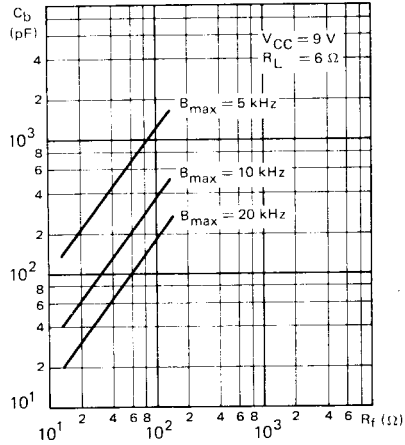
TYPICAL VALUE OF C_B VERSUS R_f AND B

CASE CB-21



PLASTIC PACKAGE

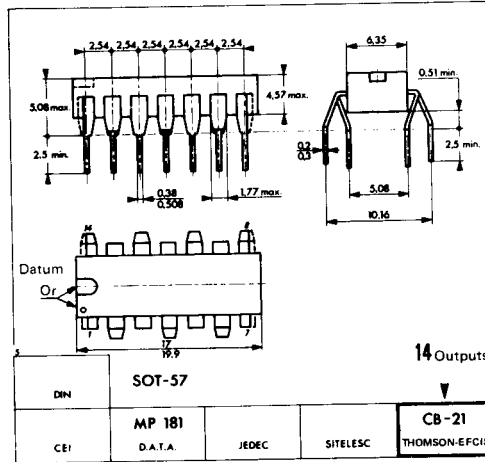

These specifications are subject to change without notice.
Please inquire with our sales offices about the availability of the different packages.

This datasheet has been downloaded from:

www.DatasheetCatalog.com

Datasheets for electronic components.