

Current Regulator Diodes

J500	J503	J506	J509
J501	J504	J507	J510
J502	J505	J508	J511

PRODUCT SUMMARY					
Part Number	Typ I _F (mA)	P _{OV} (V)	Part Number	Typ I _F (mA)	P _{OV} (V)
J500	0.24	50	J506	1.40	50
J501	0.33	50	J507	1.80	50
J502	0.43	50	J508	2.40	50
J503	0.56	50	J509	3.00	50
J504	0.75	50	J510	3.60	50
J505	1.00	50	J511	4.70	50

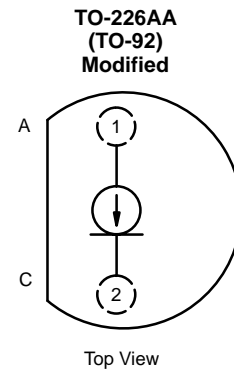

FEATURES

- Two-Lead Plastic Package
- Guaranteed $\pm 20\%$ Tolerance
- Operation from 1 V (J500–J503) to 50 V
- Excellent Temperature Stability

BENEFITS

- Simple Series Circuitry, No Separate Voltage Source
- Tight Guaranteed Circuit Performance
- Excellent Performance in Low-Voltage/Battery Circuits and High-Voltage Spike Protection
- High Circuit Stability vs. Temperature

APPLICATIONS

- Constant-Current Supply
- Current-Limiting
- Timing Circuits

DESCRIPTION

The J500 series is a family of $\pm 20\%$ range current regulators designed for demanding applications in test equipment and instrumentation. These devices utilize the JFET techniques to produce a single two-leaded device which is extremely simple to operate.

With nominal current ranges from 0.24 mA to 4.7 mA, the J500 series will meet a wide array of design requirements.

The low-cost TO-226A package ensures a cost-effective design solution.

SCHEMATIC DIAGRAM

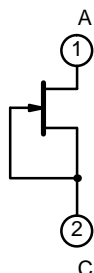

APPLICATIONS

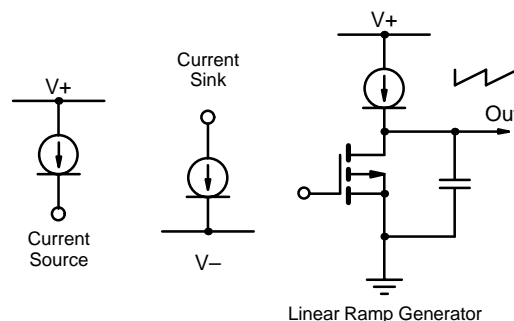

For applications information see AN103.



ABSOLUTE MAXIMUM RATINGS

Peak Operating Voltage 50 V
 Reverse Current 50 mA
 Storage Temperature -55 to 150°C

Power Dissipation^a 350 mW

Notes:

a. Derate 2.8 mW/°C above 25°C

SPECIFICATIONS (T _A = 25°C UNLESS OTHERWISE NOTED)						
Parameter	Symbol	Test Conditions	Limits			Unit
			Min	Typ ^a	Max	
Peak Operating Voltage ^b	P _{OV}	I _F = 1.1 I _{F(max)}	50	95		V
Reverse Voltage	V _R	I _R = 1 mA		0.8		
Capacitance	C _F	V _F = 25 V, f = 1 MHz		2.2		pF

Part Number	Regulator Current ^c (I _F)			Dynamic Impedance ^d (Z _d)		Knee Impedance (Z _k)	Limiting Voltage ^e (V _L)		Temperature Coefficient (θ ₁)
	V _F = 25 V			V _F = 25 V		V _F = 6 V	I _F = 0.8 I _{F(min)}		V _F = 25 V 0°C ≤ T _A ≤ 100°C
	Min	Nom	Max	Min	Typ ^a	Typ ^a	Max	Typ ^a	%/°C
J500	0.192	0.24	0.288	4.00	15	2.50	1.2	0.4	0.95
J501	0.264	0.33	0.396	2.20	10	1.60	1.3	0.5	0.81
J502	0.344	0.43	0.516	1.50	7	1.10	1.5	0.6	0.70
J503	0.448	0.56	0.672	1.20	5	0.80	1.7	0.7	0.58
J504	0.600	0.75	0.900	0.80	3.5	0.55	1.9	0.8	0.46
J505	0.800	1.00	1.200	0.50	2	0.40	2.1	0.9	0.33
J506	1.120	1.40	1.680	0.33	1.5	0.25	2.5	1.1	0.19
J507	1.440	1.80	2.160	0.20	1	0.19	2.8	1.3	0.08
J508	1.900	2.40	2.900	0.20	0.7	0.13	3.1	1.5	-0.05
J509	2.400	3.00	3.600	0.15	0.5	0.09	3.5	1.7	-0.14
J510	2.900	3.60	4.300	0.15	0.4	0.07	3.9	1.9	-0.22
J511	3.800	4.70	5.600	0.12	0.3	0.05	4.2	2.1	-0.34

Notes:

- Typical values are for DESIGN AID ONLY, not guaranteed nor subject to production testing.
- Max V_F where I_F = 1.1 I_{F(max)} is guaranteed.
- Pulse test—steady state currents may vary.
- Pulse test—steady state impedances may vary.
- Min V_F required to insure I_F = 0.8 I_{F(min)}.

NCL



TYPICAL CHARACTERISTICS ($T_A = 25^\circ\text{C}$ UNLESS OTHERWISE NOTED)

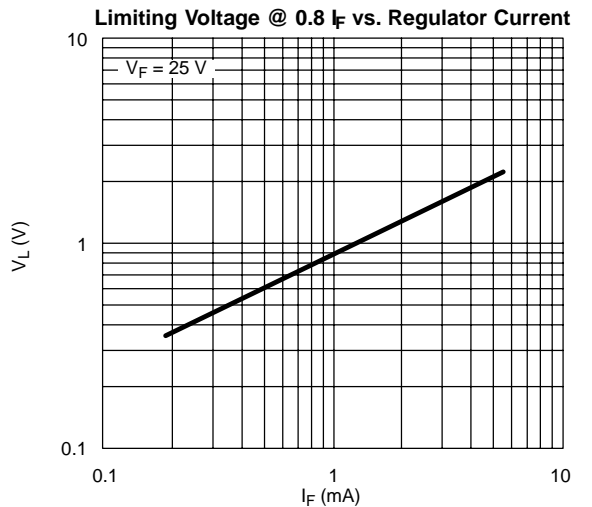
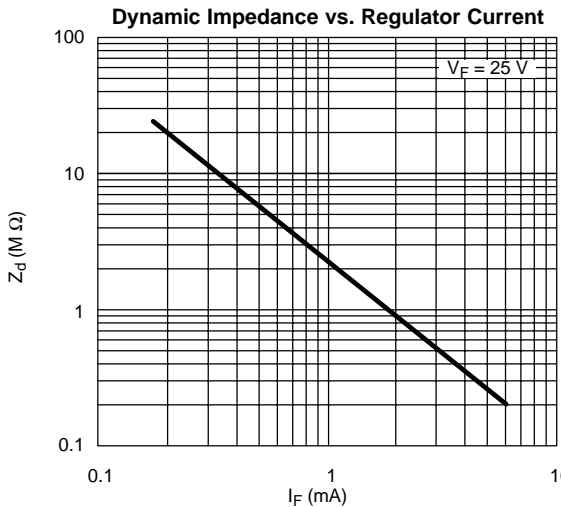
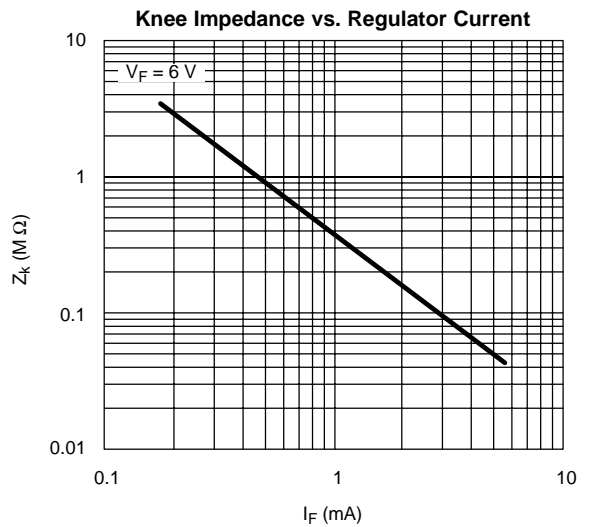
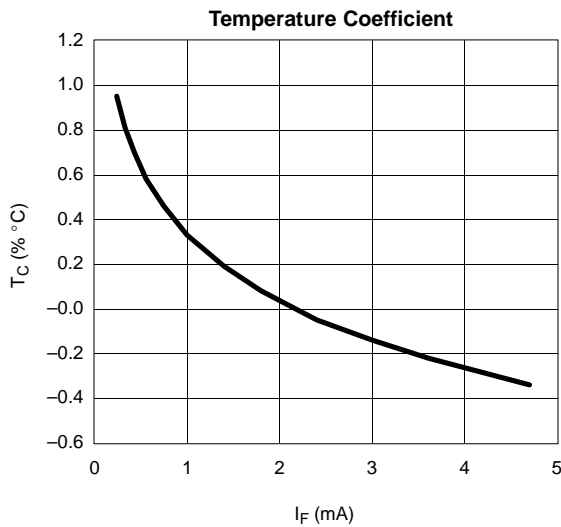
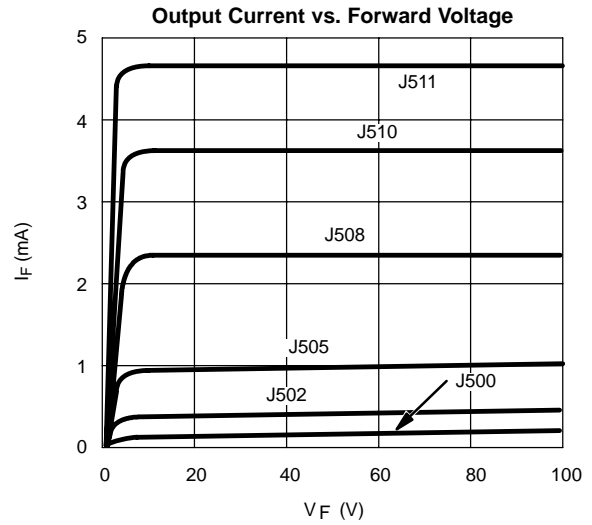
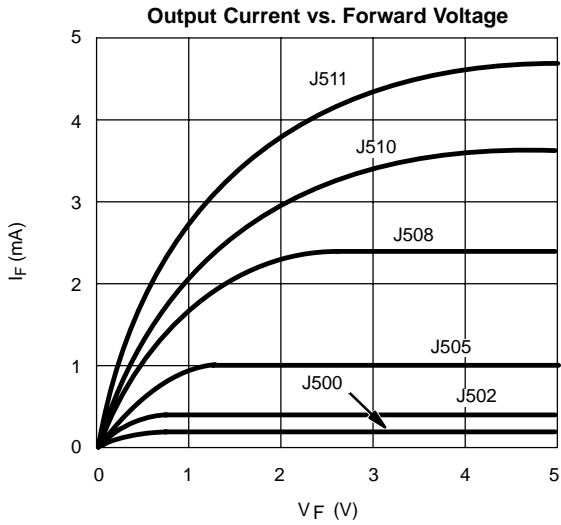

TYPICAL CHARACTERISTICS ($T_A = 25^\circ\text{C}$ UNLESS OTHERWISE NOTED)

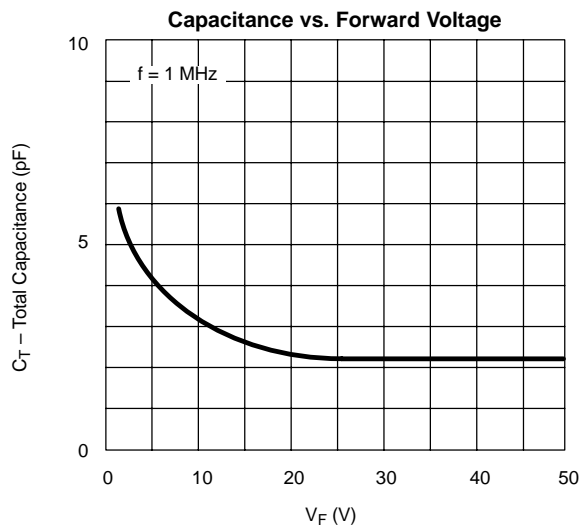
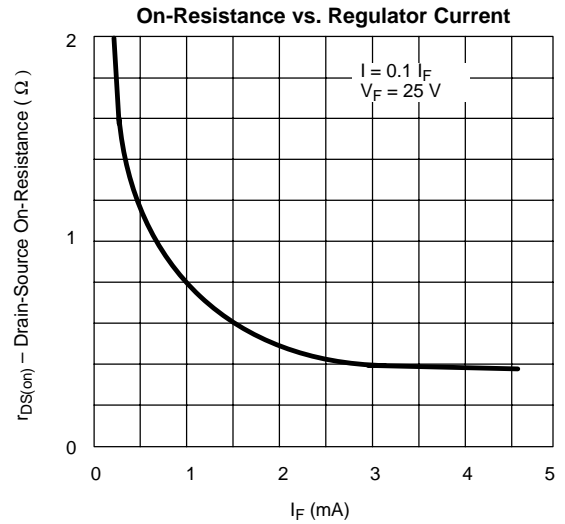
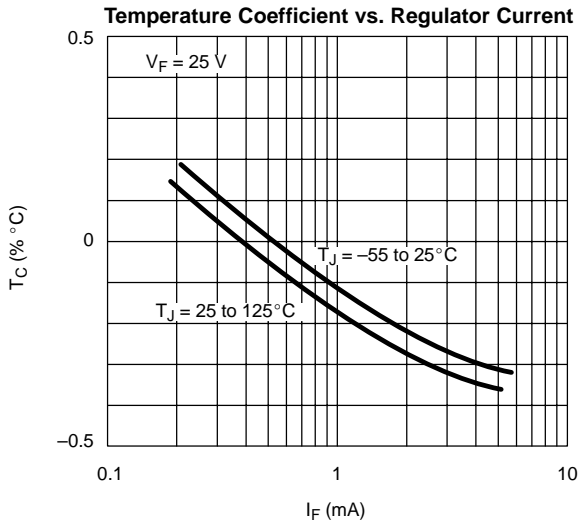

CURRENT REGULATOR DIODE V-1 CHARACTERISTIC

