

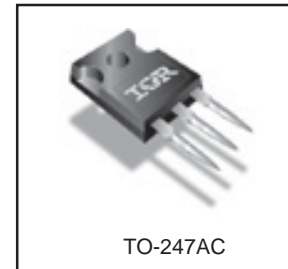
**Applications**

- Hard Switching Primary or PFS Switch
- Switch Mode Power Supply (SMPS)
- Uninterruptible Power Supply
- High Speed Power Switching
- Motor Drive

<b>V<sub>DSS</sub></b>	<b>R<sub>DS(on) typ.</sub></b>	<b>I<sub>D</sub></b>
<b>600V</b>	<b>240mΩ</b>	<b>22A</b>

**Benefits**

- Low Gate Charge Qg results in Simple Drive Requirement
- Improved Gate, Avalanche and Dynamic dv/dt Ruggedness
- Fully Characterized Capacitance and Avalanche Voltage and Current
- Enhanced Body Diode dv/dt Capability



**Absolute Maximum Ratings**

	Parameter	Max.	Units
I <sub>D</sub> @ T <sub>C</sub> = 25°C	Continuous Drain Current, V <sub>GS</sub> @ 10V	22	A
I <sub>D</sub> @ T <sub>C</sub> = 100°C	Continuous Drain Current, V <sub>GS</sub> @ 10V	14	
I <sub>DM</sub>	Pulsed Drain Current ①	88	
P <sub>D</sub> @ T <sub>C</sub> = 25°C	Power Dissipation	370	W
	Linear Derating Factor	2.9	W/°C
V <sub>GS</sub>	Gate-to-Source Voltage	± 30	V
dv/dt	Peak Diode Recovery dv/dt ③	18	V/ns
T <sub>J</sub>	Operating Junction and	-55 to + 150	
T <sub>STG</sub>	Storage Temperature Range		
	Soldering Temperature, for 10 seconds (1.6mm from case )	300	°C

**Avalanche Characteristics**

Symbol	Parameter	Typ.	Max.	Units
E <sub>AS</sub>	Single Pulse Avalanche Energy②	—	380	mJ
I <sub>AR</sub>	Avalanche Current①	—	22	A
E <sub>AR</sub>	Repetitive Avalanche Energy①	—	37	mJ

**Thermal Resistance**

Symbol	Parameter	Typ.	Max.	Units
R <sub>θJC</sub>	Junction-to-Case④	—	0.34	°C/W
R <sub>θCS</sub>	Case-to-Sink, Flat, Greased Surface	0.24	—	
R <sub>θJA</sub>	Junction-to-Ambient④	—	40	

# IRFP22N60K

International  
IR Rectifier

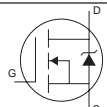
## Static @ $T_J = 25^\circ\text{C}$ (unless otherwise specified)

Symbol	Parameter	Min.	Typ.	Max.	Units	Conditions
$V_{(BR)DSS}$	Drain-to-Source Breakdown Voltage	600	—	—	V	$V_{GS} = 0V, I_D = 250\mu A$
$\Delta V_{(BR)DSS}/\Delta T_J$	Breakdown Voltage Temp. Coefficient	—	0.30	—	V/°C	Reference to $25^\circ\text{C}$ , $I_D = 1\text{mA}$ ④
$R_{DS(on)}$	Static Drain-to-Source On-Resistance	—	240	280	mΩ	$V_{GS} = 10V, I_D = 13A$ ④
$V_{GS(th)}$	Gate Threshold Voltage	3.0	—	5.0	V	$V_{DS} = V_{GS}, I_D = 250\mu A$
$I_{DSS}$	Drain-to-Source Leakage Current	—	—	50	μA	$V_{DS} = 600V, V_{GS} = 0V$
		—	—	250	μA	$V_{DS} = 480V, V_{GS} = 0V, T_J = 125^\circ\text{C}$
$I_{GSS}$	Gate-to-Source Forward Leakage	—	—	100	nA	$V_{GS} = 30V$
	Gate-to-Source Reverse Leakage	—	—	-100	nA	$V_{GS} = -30V$

## Dynamic @ $T_J = 25^\circ\text{C}$ (unless otherwise specified)

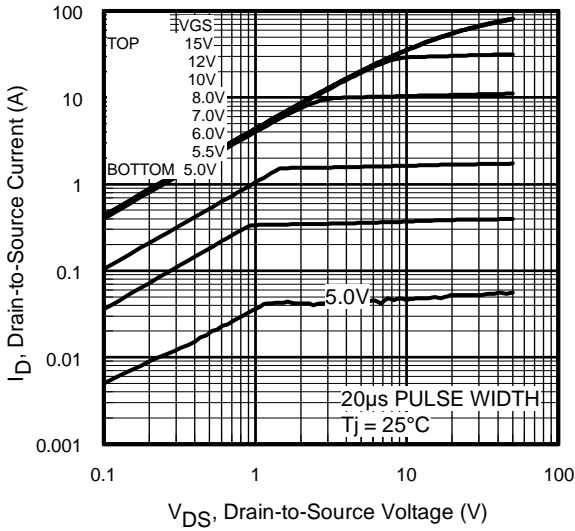
Symbol	Parameter	Min.	Typ.	Max.	Units	Conditions
$g_{fs}$	Forward Transconductance	11	—	—	S	$V_{DS} = 50V, I_D = 13A$
$Q_g$	Total Gate Charge	—	—	150	nC	$I_D = 22A$
$Q_{gs}$	Gate-to-Source Charge	—	—	45		$V_{DS} = 480V$
$Q_{gd}$	Gate-to-Drain ("Miller") Charge	—	—	76		$V_{GS} = 10V$ ④
$t_{d(on)}$	Turn-On Delay Time	—	26	—	ns	$V_{DD} = 300V$
$t_r$	Rise Time	—	99	—		$I_D = 22A$
$t_{d(off)}$	Turn-Off Delay Time	—	48	—		$R_G = 6.2\ \Omega$
$t_f$	Fall Time	—	37	—		$V_{GS} = 10V$ ④
$C_{iss}$	Input Capacitance	—	3570	—	pF	$V_{GS} = 0V$
$C_{oss}$	Output Capacitance	—	350	—		$V_{DS} = 25V$
$C_{riss}$	Reverse Transfer Capacitance	—	36	—		$f = 1.0\text{MHz}$
$C_{oss}$	Output Capacitance	—	4710	—		$V_{GS} = 0V, V_{DS} = 1.0V, f = 1.0\text{MHz}$
$C_{oss}$	Output Capacitance	—	92	—		$V_{GS} = 0V, V_{DS} = 480V, f = 1.0\text{MHz}$
$C_{oss\ eff.}$	Effective Output Capacitance	—	180	—		$V_{GS} = 0V, V_{DS} = 0V\ \text{to}\ 480V$ ⑤

## Diode Characteristics

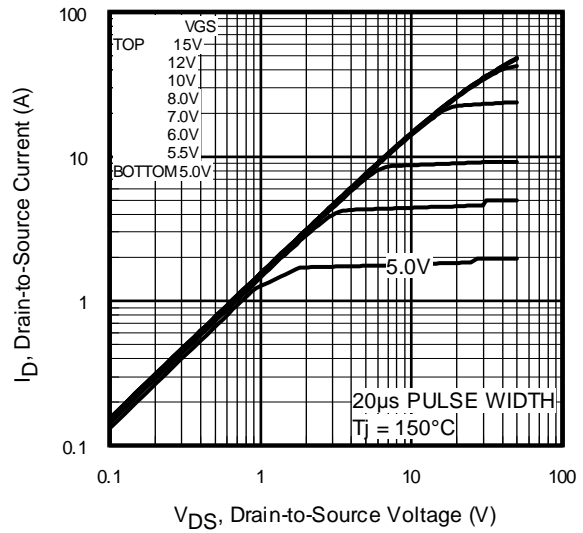
Symbol	Parameter	Min.	Typ.	Max.	Units	Conditions
$I_S$	Continuous Source Current (Body Diode)	—	—	22	A	MOSFET symbol showing the integral reverse p-n junction diode. 
$I_{SM}$	Pulsed Source Current (Body Diode) ①	—	—	88		
$V_{SD}$	Diode Forward Voltage	—	—	1.5	V	$T_J = 25^\circ\text{C}, I_S = 22A, V_{GS} = 0V$ ④
$t_{rr}$	Reverse Recovery Time	—	590	890	ns	$T_J = 25^\circ\text{C}$
		—	670	1010		$T_J = 125^\circ\text{C}$
$Q_{rr}$	Reverse Recovery Charge	—	7.2	11	μC	$T_J = 25^\circ\text{C}$
		—	8.5	13		$T_J = 125^\circ\text{C}$
$I_{RRM}$	Reverse Recovery Current	—	26	39	A	$T_J = 25^\circ\text{C}$
$t_{on}$	Forward Turn-On Time	Intrinsic turn-on time is negligible (turn-on is dominated by $L_S + L_D$ )				

### Notes:

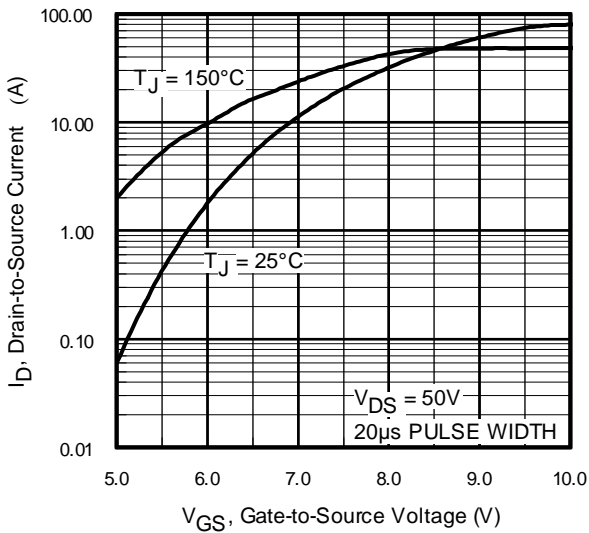
- ① Repetitive rating; pulse width limited by max. junction temperature.
- ② Starting  $T_J = 25^\circ\text{C}$ ,  $L = 1.5\text{mH}$ ,  $R_G = 25\ \Omega$ ,  $I_{AS} = 22A$
- ③  $I_{SD} \leq 22A$ ,  $di/dt \leq 540\ \text{A}/\mu\text{s}$ ,  $V_{DD} \leq V_{(BR)DSS}$ ,  $T_J \leq 150^\circ\text{C}$ .
- ④ Pulse width  $\leq 300\ \mu\text{s}$ ; duty cycle  $\leq 2\%$ .
- ⑤  $C_{oss\ eff.}$  is a fixed capacitance that gives the same charging time as  $C_{oss}$  while  $V_{DS}$  is rising from 0 to 80%  $V_{DSS}$ .
- ⑥  $R_\theta$  is measured at  $T_J$  approximately  $90^\circ\text{C}$



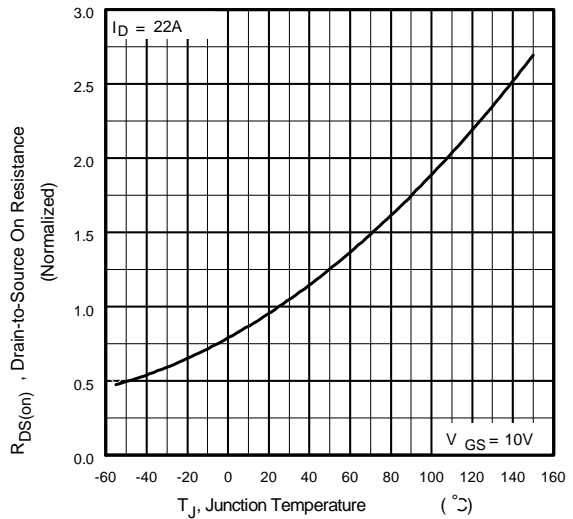
**Fig 1.** Typical Output Characteristics



**Fig 2.** Typical Output Characteristics

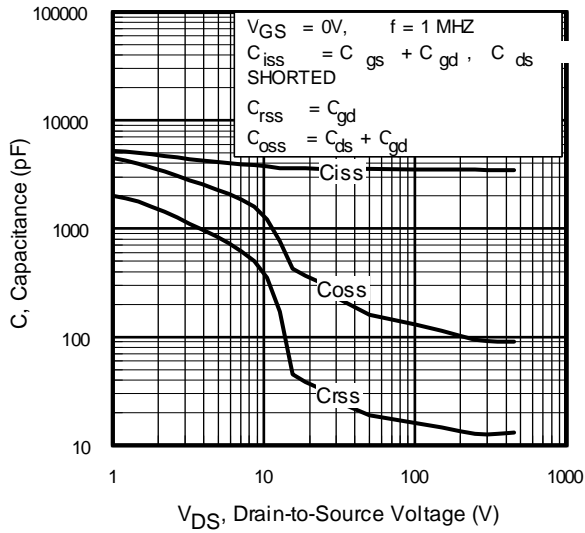


**Fig 3.** Typical Transfer Characteristics

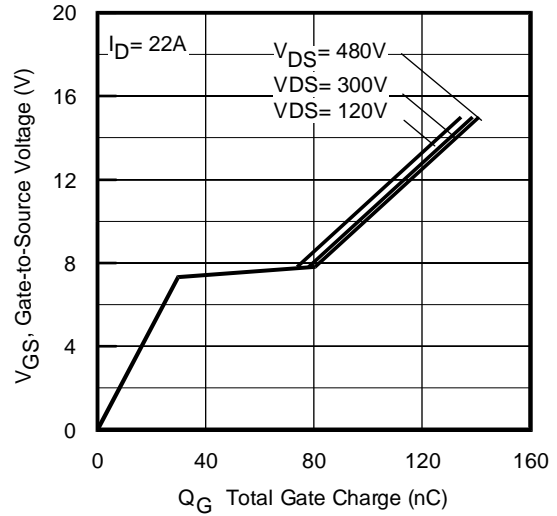


**Fig 4.** Normalized On-Resistance Vs. Temperature

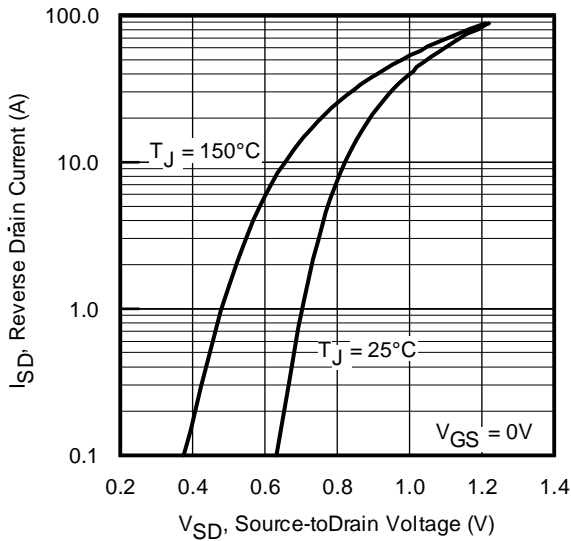
# IRFP22N60K



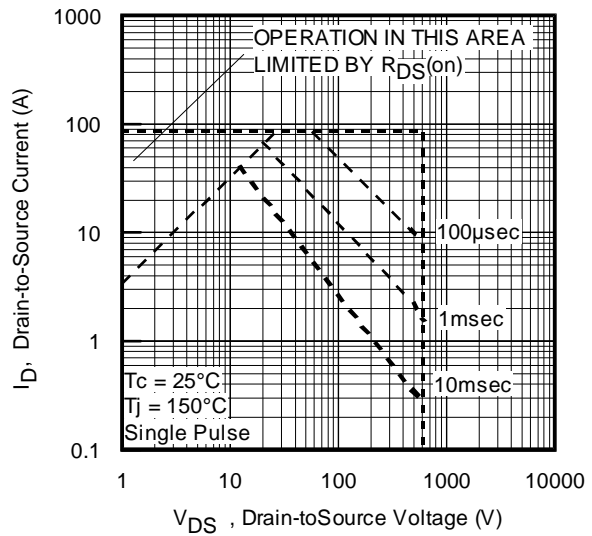
**Fig 5.** Typical Capacitance Vs. Drain-to-Source Voltage



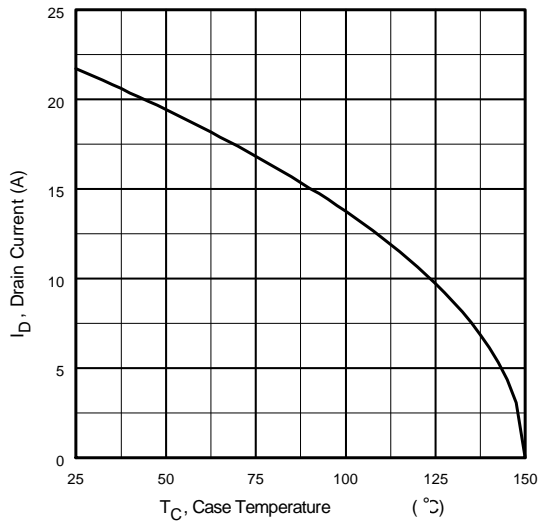
**Fig 6.** Typical Gate Charge Vs. Gate-to-Source Voltage



**Fig 7.** Typical Source-Drain Diode Forward Voltage



**Fig 8.** Maximum Safe Operating Area



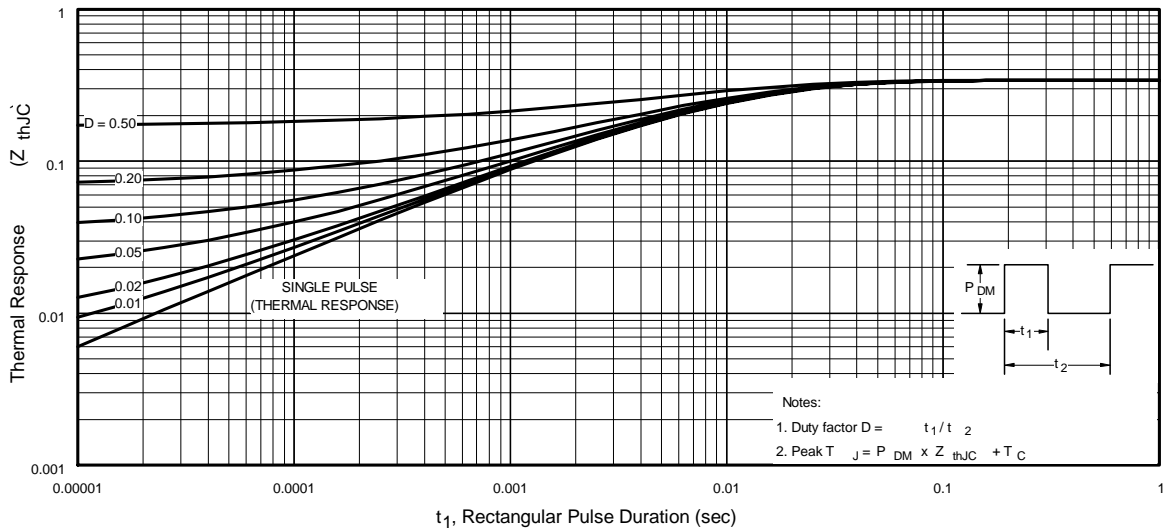
**Fig 9.** Maximum Drain Current Vs. Case Temperature



**Fig 10a.** Switching Time Test Circuit

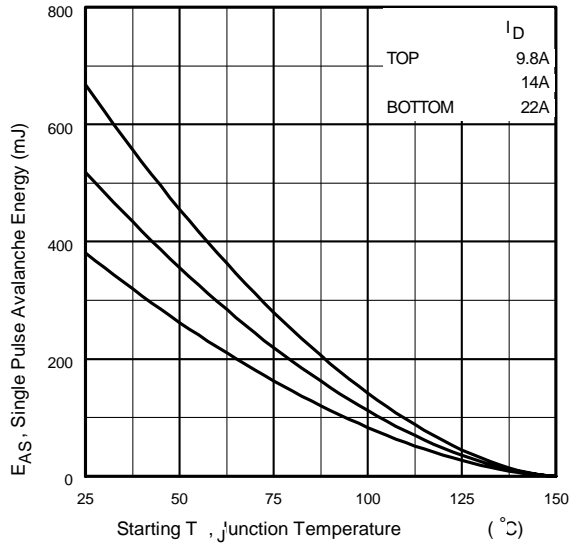


**Fig 10b.** Switching Time Waveforms

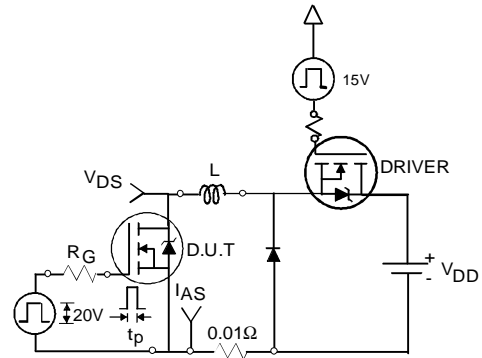


**Fig 11.** Maximum Effective Transient Thermal Impedance, Junction-to-Case

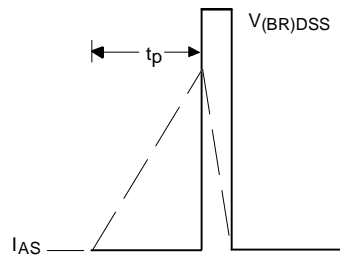
# IRFP22N60K



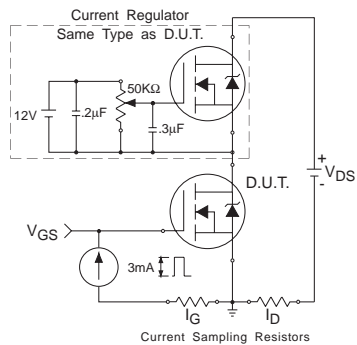
**Fig 12a.** Maximum Avalanche Energy Vs. Drain Current



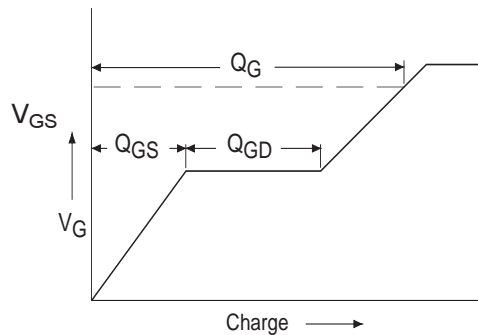
**Fig 12c.** Unclamped Inductive Test Circuit



**Fig 12d.** Unclamped Inductive Waveforms



**Fig 13a.** Gate Charge Test Circuit



**Fig 13b.** Basic Gate Charge Waveform

## Peak Diode Recovery dv/dt Test Circuit



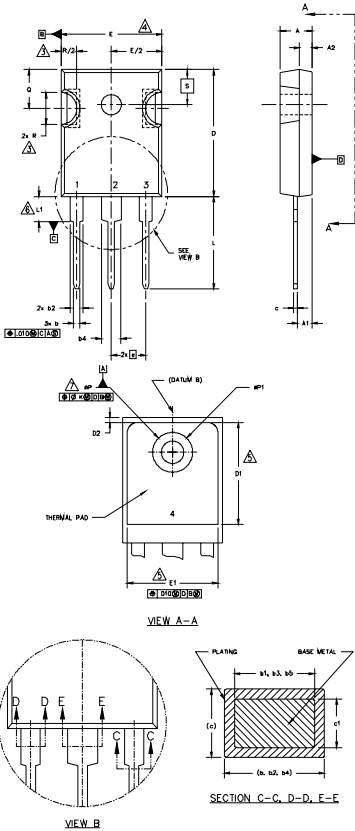
\*  $V_{GS} = 5V$  for Logic Level Devices

**Fig 14.** For N-Channel HEXFET® Power MOSFETs

# IRFP22N60K

International  
**IR** Rectifier

TO-247AC Package Outline Dimensions are shown in millimeters (inches)



NOTES:

1. DIMENSIONING AND TOLERANCING PER ASME Y14.5M 1994.
2. DIMENSIONS ARE SHOWN IN INCHES [MILLIMETERS]
3. CONTOUR OF SLOT OPTIONAL.
4. DIMENSION D & E DO NOT INCLUDE MOLD FLASH. MOLD FLASH SHALL NOT EXCEED .005" (0.127) PER SIDE. THESE DIMENSIONS ARE MEASURED AT THE OUTERMOST EXTREMES OF THE PLASTIC BODY.
5. THERMAL PAD CONTOUR OPTIONAL WITHIN DIMENSIONS D1 & E1.
6. LEAD FINISH UNCONTROLLED IN L1.
7. ØP TO HAVE A MAXIMUM DRAFT ANGLE OF 1.5° TO THE TOP OF THE PART WITH A MAXIMUM HOLE DIAMETER OF .154" [3.91].
8. OUTLINE CONFORMS TO JEDEC OUTLINE TO-247 WITH THE EXCEPTION OF DIMENSION c.

SYMBOL	DIMENSIONS				NOTES
	INCHES		MILLIMETERS		
	MIN.	MAX.	MIN.	MAX.	
A	.183	.209	4.65	5.31	
A1	.087	.102	2.21	2.59	
A2	.059	.098	1.50	2.49	
b	.039	.055	0.99	1.40	
b1	.039	.053	0.99	1.35	
b2	.065	.094	1.65	2.39	
b3	.065	.092	1.65	2.37	
b4	.102	.135	2.59	3.43	
b5	.102	.133	2.59	3.38	
c	.015	.034	0.38	0.86	
c1	.015	.030	0.38	0.76	
D	.776	.815	19.71	20.70	4
D1	.515	-	13.08	-	5
D2	.020	.030	0.51	0.76	
E	.602	.625	15.29	15.87	4
E1	.540	-	15.72	-	
e	.215 BSC		5.46 BSC		
Øk	.010		2.54		
L	.559	.634	14.20	16.10	
L1	.146	.169	3.71	4.29	
N	3		7.62 BSC		
ØP	.140	.144	3.56	3.66	
ØP1	-	.275	-	6.98	
Ø	.209	.224	5.31	5.69	
R	.178	.216	4.52	5.49	
S	.217 BSC		5.51 BSC		

LEAD ASSIGNMENTS

HEXFET

1. - GATE
2. - DRAIN
3. - SOURCE
4. - DRAIN

IGBTs, CoPACK

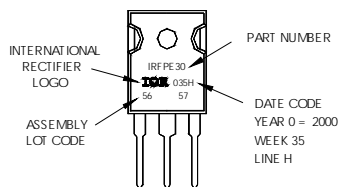
1. - GATE
2. - COLLECTOR
3. - EMITTER
4. - COLLECTOR

DIODES

1. - ANODE/OPEN
2. - CATHODE
3. - ANODE

## TO-247AC Part Marking Information

EXAMPLE: THIS IS AN IRFPE30  
WITH ASSEMBLY  
LOT CODE 5657  
ASSEMBLED ON WW 35, 2000  
IN THE ASSEMBLY LINE "H"  
**Note:** "P" in assembly line  
position indicates "Lead-Free"



Data and specifications subject to change without notice.  
This product has been designed and qualified for the Industrial market.  
Qualification Standards can be found on IR's Web site.

International  
**IR** Rectifier

IR WORLD HEADQUARTERS: 233 Kansas St., El Segundo, California 90245, USA Tel: (310) 252-7105  
TAC Fax: (310) 252-7903

Visit us at [www.irf.com](http://www.irf.com) for sales contact information.08/04

[www.irf.com](http://www.irf.com)